

9U Wall Mount Cabinet - 102 Series, 18 Inches Deep, Flat Packed

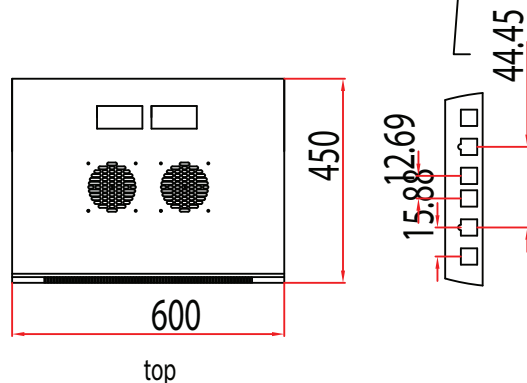
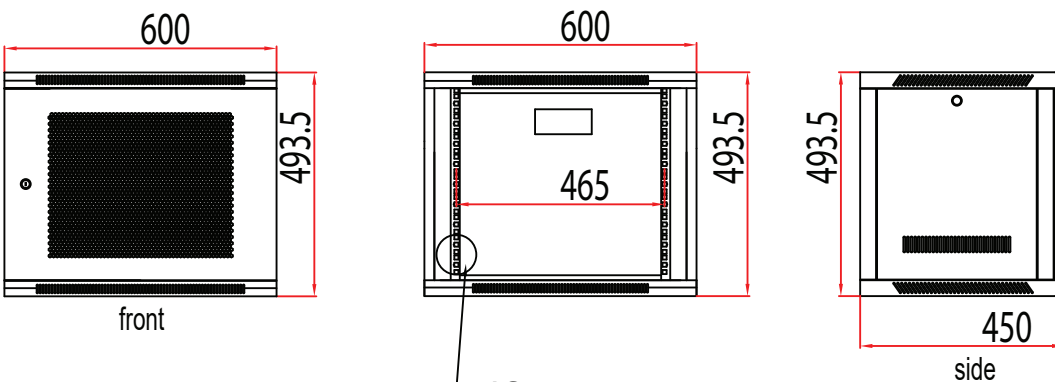
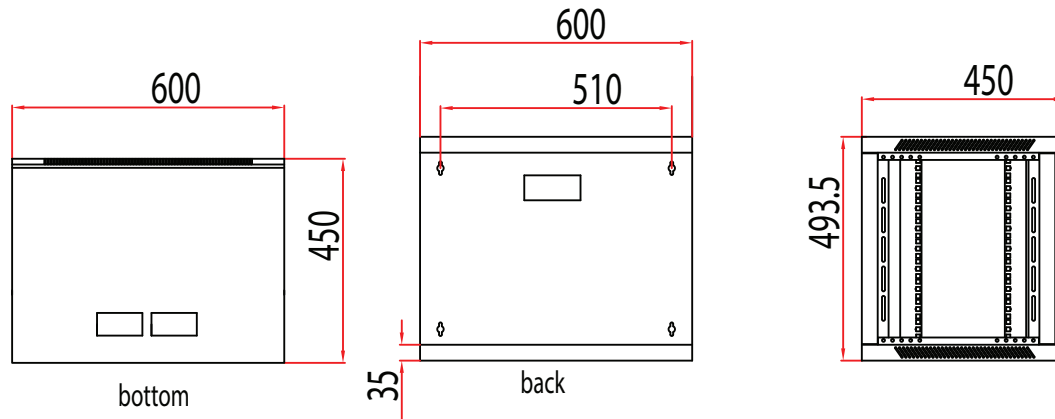

Optimized for Indoor Applications: Specifically designed to thrive in indoor environments, ensuring durability and optimal performance.

Convenient Flat-Packed Delivery: Arrives flat-packed for easy handling and efficient transportation, simplifying the unboxing and setup process.

Secure Access: Features locking front and side panels, providing secure access and safeguarding your equipment against unauthorized access.

Easily Customizable: Comes with removable front and side panels, allowing for quick adjustments and effortless maintenance.

Enhanced Ventilation: Well-ventilated front and side panels designed to maintain optimal airflow, keeping equipment cool and efficiently running.

Enhanced Airflow and Monitoring: Equipped with a hexagonal mesh front door that significantly improves airflow, ensuring your equipment stays cool, while still allowing for necessary visual checks.

Versatile Cable Management: Includes knockouts for cabling at the top, bottom, and rear of the cabinet, facilitating smooth and organized cable routing.

Cooling Efficiency: Preinstalled fan with space available to add a second fan, ensuring double the airflow for high-power equipment.

Ready for Wall Mounting: Features pre-cut holes for wall mounting, making installation straightforward and secure, ideal for saving space in compact areas.

Cage Nut Rails	Front & Rear
Color	Black
Delivery Style	Flat Packed
Door Style	Steel Hexagonal Mesh
Hinged Swing Out Design	No
Internal Mounting Format	19"
Key Lock Set (2 Keys per Set)	1 Set
Load Capacity	130 lbs
Locking Side Panels	Yes
Preinstalled 80CFM 110V Fans	1
Rack Height (Assembled)	19.75 Inch
Rack Size Depth (Internal)	18" (14")
Rack Size Width (Internal)	24" (19")
Reinforced Door Frame	Yes
Revision	Rev. 2
RMU	9U
Structure & Fabrication	SPCC Cold-Rolled Steel Sheets
Vented Side Panels	Removable