

18U Open Frame Swing Out Wall Mount Rack - 201 Series, 12 Inches Deep, Flat Packed

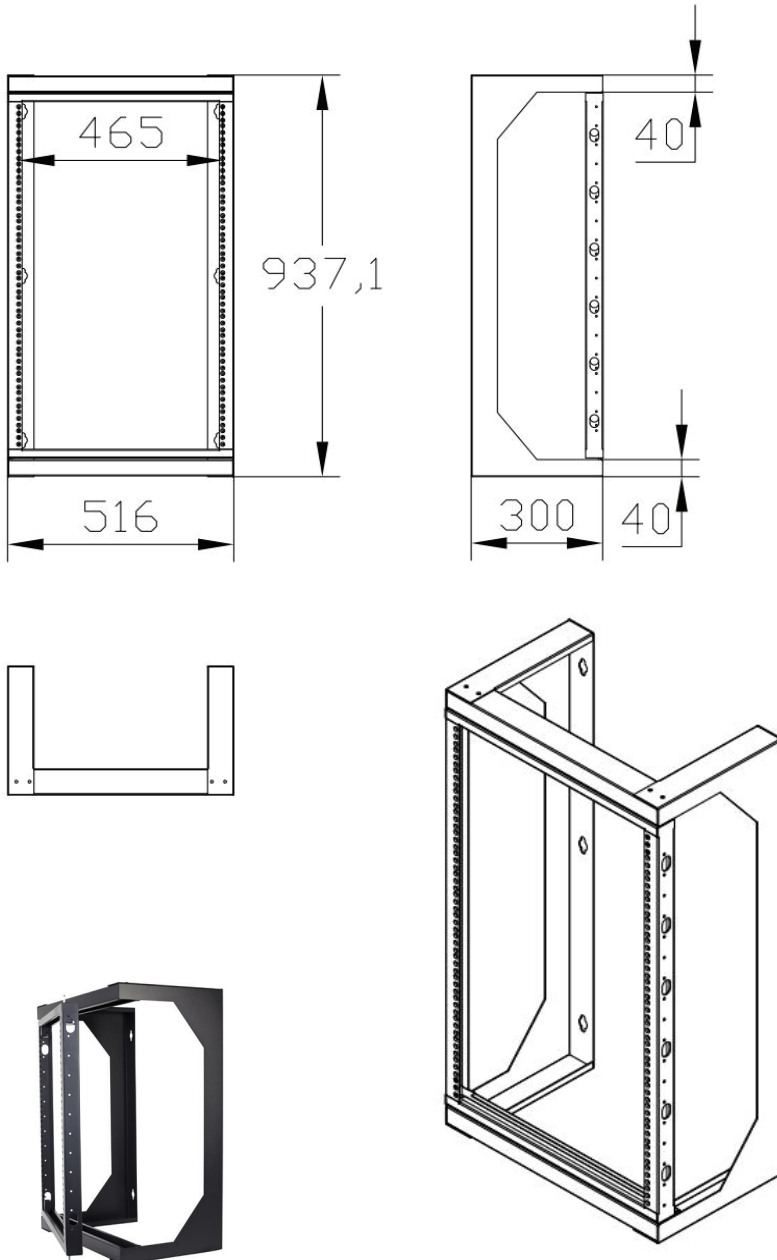

Maximize Floor Space: Frees up valuable floor space by securing equipment off the ground and onto the wall, ideal for optimizing room in crowded or compact environments.

Easy Access: Open frame design provides easy access to equipment and cables for maintenance, upgrades, or troubleshooting.

Enhanced Airflow: The open structure ensures continuous airflow, helping to keep equipment cool and reduce the risk of overheating.

Versatile Installation: Can be mounted in various locations, including closets, under desks, or in any area where space is at a premium.

Cost-Effective: Provides a cost-efficient solution for mounting networking equipment without the need for large, expensive cabinets or enclosures.

Organizational Aid: Helps organize and consolidate network equipment, improving cable management and creating a cleaner, more professional setup.

Compliance	EIA-310D
Delivery Style	Knockdown
Dual Tapped Rails	Yes (#12-24)
Electrostatic Powdercoat MicroFinish	Black
Hinged Swing Out Design	Yes
Load Capacity	150 lbs
Mounting Format	19"
Numbered RU positions	No
Rack Height (Assembled)	37 Inch
Rack Size Depth (Internal)	12"
Rack Size Width (Internal)	21" (19")
RMU	18U
Screws & Washers (#12-24)	16 each